



YLI ELECTRONIC



# Fail Safe Electric Drop Bolt

## Parameters

Model	YB-100	YB-100+	YB-100+(LED)	YB-100S
Face Plate	205Lx35Wx40H	205Lx35Wx40H	205Lx35Wx40H	205Lx35Wx40H
Strike	90Lx25Wx2H	90Lx25Wx2H	90Lx25Wx2H	90Lx25Wx2H
Decorative Panel	215Lx40Wx0.5H	215Lx40Wx0.5H	215Lx40Wx0.5H	215Lx40Wx0.5H
Bolt	16mmx16mm	16mmx16mm	16mmx16mm	16mmx16mm
Voltage	Start 900mA, Standby 110mA	Start 900mA, Standby 110mA	Start 900mA, Standby 110mA	Start 900mA, Standby 120mA
Current	12VDC	12VDC	12VDC	12VDC
Time Delay		0/3/6/9 sec	0/3/6/9 sec	
Signal Output	NO、COM	NO、COM	NO、COM	
LED			YES	
Weight	0.72kg	0.72kg	0.72kg	0.72kg

## Dimensions

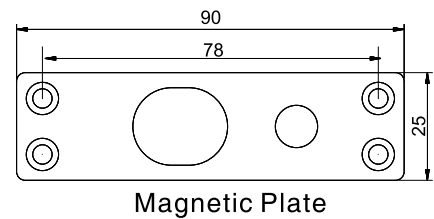
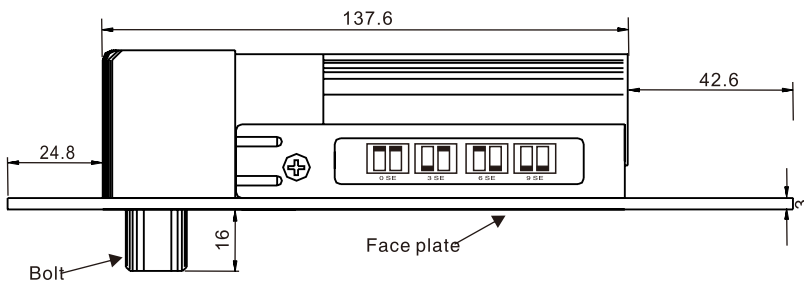

Magnetic Plate

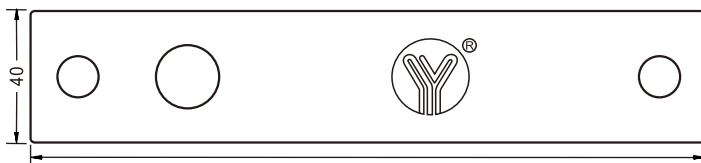

Decorative Plate

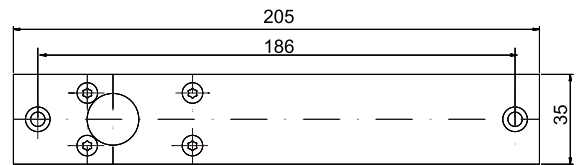

Face plate

Model	Red	Black	White	White	LED
YB-100S	✓	✓			
YB-100	✓	✓	✓	✓	
YB-100+	✓	✓	✓	✓	
YB-100+(LED)	✓	✓	✓	✓	✓

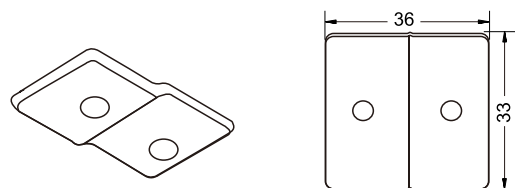

Extended Plate

# Installation

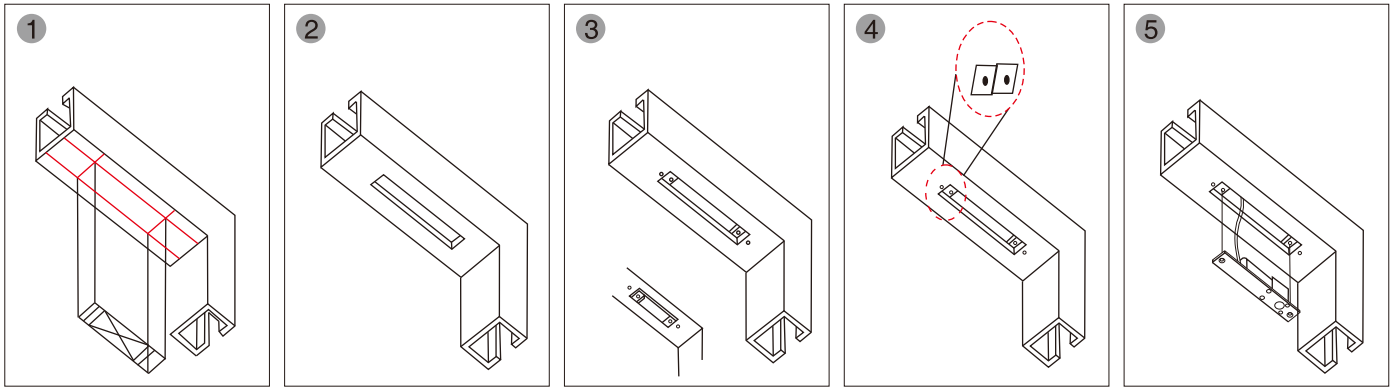

1 Place lock body template to match with door frame center line

2 Cut hole

3 Fix mounting plate (For hollow metal frame)

4 Connect wires

5 Mount lock body on the door frame and test

# Installation Schematic

## Frameless Glass Door

Suitable for 10-15mm glass door, BBK-600/601/602 for Frameless Glass Door.

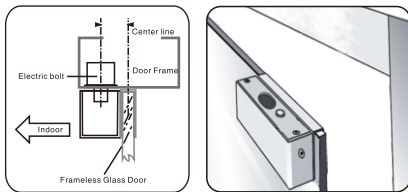

## Fully Frameless Glass Door

BBK-700 for Fully Frameless Glass Door

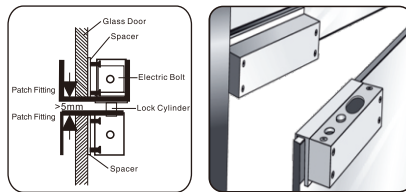

## Aluminium Bracket for Narrow Door

BBK-500 for Narrow Door

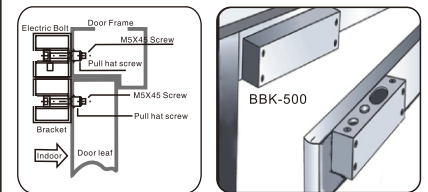

# Wiring Diagram

